

SD103AWSQ & SD103BWSQ & SD103CWSQ

RoHS
COMPLIANT

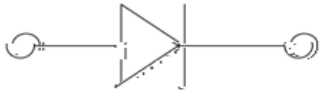

" (SR[\ PHHWV 8/ BELCOWPUDWLQJ DQG KDORJ
 " ORLVWXUH 6HQVLWLYLW\ /HYHO
 ")RU 6XUIDFH ORXQW \$SSOLFDWLRQ
 " \$50 9 9 9
 ")\$9 \$
 " 3DUW QR ZLWRKHVXQVL\$ (34 4 TXDOLILHG

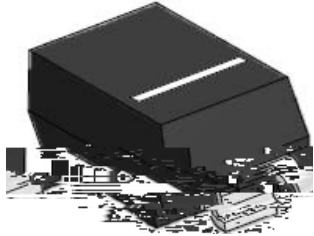

SOD323

Mechanical Data

" H4 2) 8QOHVV RWKHUĀLVH VSHFLILHG

PARAMETER	SYMBOL	UNIT	CONDITIONS	VALUE
5SHSHWLWLYH SHDN UHYHU ₅₀ YH YROWDJH9			9	6' \$:64
				6' %:64
				6' &:64
\$YHUDJH)RUZDUG &XUHHQW		\$,	
3HDN)RUZDUG 6XUJH &XUHHQW		\$, PV KDOI VLQH	
3RZHU 'LVVLSDWLRQ	3	P:		
7KHUPDO 5HVLVWDQFH \$PELHQW	-XQFWLRQ 5WK-\$		WR	
-XQFWLRQ 7HPSHUDWXUH 7				WR
6WRUDJH 7HPSHUDWXUH 5DQJH			7	WR



SD103AWSQ & SD103BWSQ & SD103CWSQ

v Electrical Characteristics Ä 7D

8 QOHVV RWKHUŽLVH VSHFLILHG

PARAMETER	SYMBOL	UNIT	CONDITIONS	PART	MIN	MAX
)RUZDUG 9ROWDJH)	9) P\$			
) P\$			
5HYHUVH /HDNDJH &XJUHQWX\$			9 ₅ 9	6' \$:64		
			9 ₅ 9	6' %:64		
			9 ₅ 9	6' &:64		
5HYHUVH %UHDNGRZQ ₅ 9ROWDJH			9 9 X\$	6' \$:64		
				6' %:64		
				6' &:64		
-XQFWLRQ &DSDF	LWDQFH		& 5 S9 I Q)+		9	
5HYHUVH 5HFRYHU\ 7LPH		W) .5 P\$,UU P\$ 5		,	

v Ordering Information ([DP SOH

PREFERED P/N	PACKING CODE	UNIT WEIGHT(g)	MINIMUM PACKAGE(pcs)	INNER BOX QUANTITY(pcs)	OUTER CARTON QUANTITY(pcs)	DELIVERY MODE
6' \$:64)	\$SSUR[LPDWH				
6' %:64						
6' &:64						



SD103AWSQ & SD103BWSQ & SD103CWSQ

vCharacteristics 7 \ S L F D O
Fig.1: $P_D - T_A$

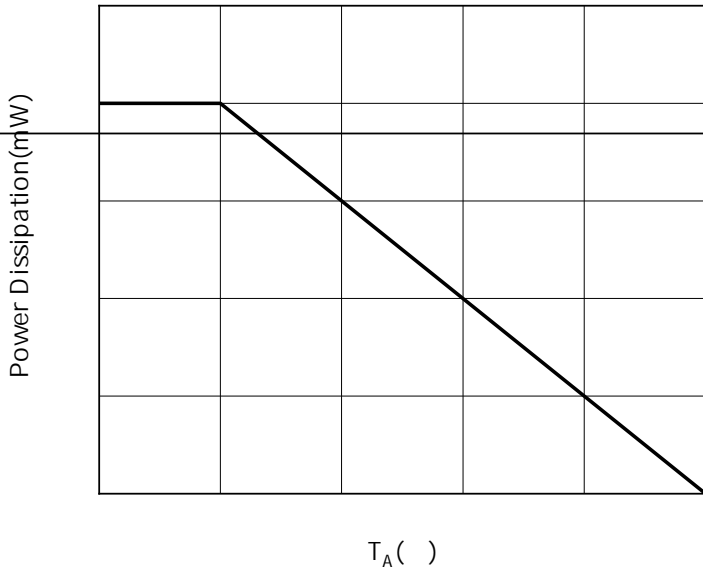
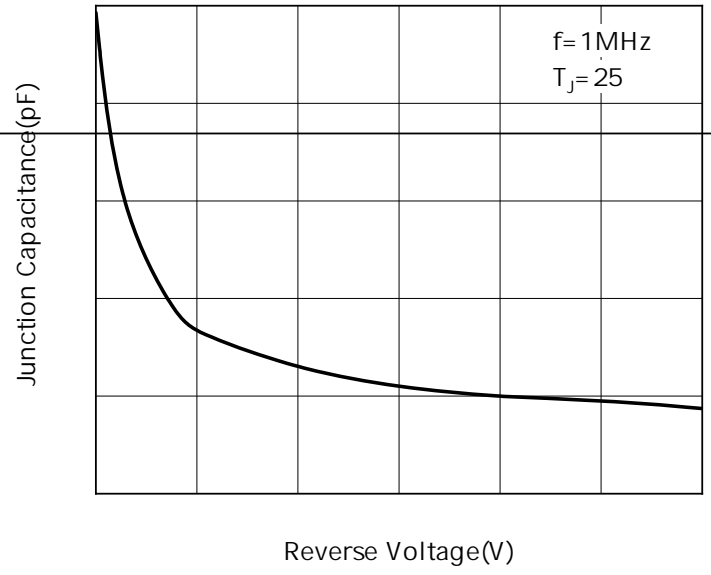

Fig.2: Capacitance Characteristics





SD103AWSQ & SD103BWSQ & SD103CWSQ

vOutline Dimensions

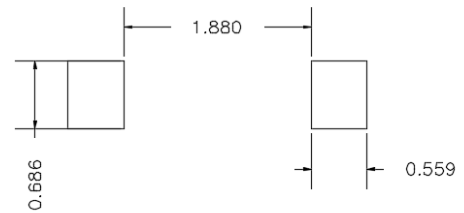
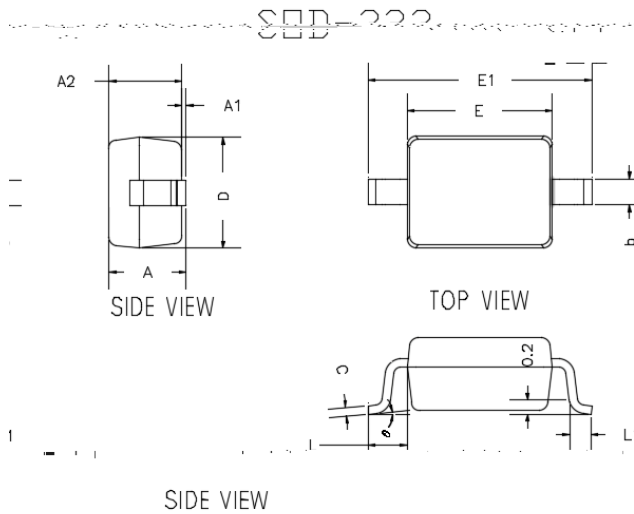

UNIT: mm

SUGGESTED SOLDER PAD LAYOUT

DIMENSIONS				
DIM	INCHES		MM	
	MIN	MAX	MIN	MAX
A	---	0.0393	---	1.0000
A1	0.0000	0.0039	0.0000	0.1000
A2	0.0314	0.0354	0.8000	0.9000
b	0.0098	0.0157	0.2500	0.4000
c	0.0031	0.0059	0.0800	0.1500
E	0.0472	0.0551	1.2000	1.4000
E1	0.0629	0.0709	1.6000	1.8000
E1	0.0984	0.1063	2.5000	2.7000
L	0.0187TYP		0.475TYP	
L1	0.0098	0.0157	0.250	0.400
e	C*	8*	C*	8*

vMarking Information

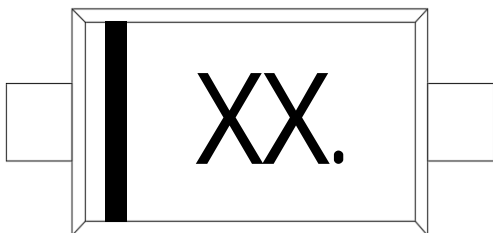

	Marking
SD103AWSQ	6
SD103BWSQ	6
SD103CWSQ	6

```

1RWH
$OO PDUNLQJ LV DW PLGGOH RI WKH SURGXFW ERG\
$OO PDUNLQJ LV LQ ODVHU PDUNLQJ
%RG\ FRORU %ODFN
;;; LV ODUNLQJ &RGH
  
```

